



RX 60 Technical Data Electric Forklift Truck

[RX 60-40](#)

[RX 60-40/600](#)

[RX 60-45](#)

[RX 60-45/600](#)

[RX 60-50](#)

[RX 60-50/600](#)



This specification sheet to VDI Guidelines 2198 only gives the technical figures for the standard truck. Different tyres, other masts, additional equipment etc. could give different figures.

		STILL	STILL	STILL	STILL	STILL	STILL	STILL		
Characteristics	1.1	Manufacturer								
	1.2	Manufacturer's model designation	RX 60-35/600	RX 60-40	RX 60-40/600	RX 60-45	RX 60-45/600	RX 60-50	RX 60-50/600	
	1.2.1	Manufacturer's type designation	6367	6327	6368	6328	6369	6329	6330	
	1.3	Truck type	Electric	Electric	Electric	Electric	Electric	Electric	Electric	
	1.4	Operation	Rider seated	Rider seated	Rider seated	Rider seated	Rider seated	Rider seated	Rider seated	
	1.5	Rated capacity	Q t	3.5	4.0	4.0	4.5	4.5	4.99	5.0
	1.6	Load centre	c mm	600	500	600	500	600	500	600
	1.8	Load distance	x mm	525	525	525	525	535	535	535
	1.9	Wheel base	y mm	2021	2021	2021	2021	2021	2021	2088
Weights	2.1	Truck weight	kg	6495	6477	6810	6793	7145	7121	7711
	2.2	Axle load, laden, front	kg	8748	9296	9587	10112	10441	10917	11547
	2.2	Axle load, laden, rear	kg	1247	1181	1223	1181	1204	1194	1154
	2.3	Axle load, unladen, front	kg	3300	3268	3361	3329	3413	3372	3845
	2.3	Axle load, unladen, rear	kg	3195	3209	3449	3463	3732	3749	3866
Wheel chassis	3.1	Tyres		SE	SE	SE	SE	SE	SE	SE
	3.2	Tyre size, front		250/70-15	250/70-15	355/50-15	355/50-15	355/50-15	355/50-15	355/50-15
	3.3	Tyre size, rear		200/75-9	200/75-9	200/75-9	200/75-9	200/75-9	200/75-9	200/75-9
	3.5	Number of wheels front (x=driven)		2x	2x	2x	2x	2x	2x	2x
	3.5	Number of wheels rear (x=driven)		2	2	2	2	2	2	2
	3.6	Track width, front	b ₁₀ mm	1030	1030	1104	1104	1104	1104	1104
	3.7	Track width, rear	b ₁₁ mm	920	920	920	920	920	920	920
Basic dimensions	4.1	Tilt Mast/Fork carriage, forward	°	3	3	3	3	3	3	3
	4.1	Tilt Mast/Fork carriage, back	°	9	9	9	9	9	9	6
	4.2	Height, mast lowered	h ₁ mm	2300	2300	2300	2300	2300	2300	2300
	4.3	Free lift	h ₂ mm	160	160	160	160	160	160	160
	4.4	Lift**	h ₃ mm	2980	2980	2980	2980	2980	2980	2780
	4.5	Height, mast raised	h ₄ mm	3762	3762	3987	3987	3987	3987	3935
	4.7	Height over overhead guard (cab)	h ₆ mm	2322	2322	2320	2320	2320	2320	2320
	4.8	Seat height/stand height rel. to SIP	h ₇ mm	1251	1251	1249	1249	1249	1249	1249
	4.12	Coupling height	h ₁₀ mm	546/421	546/421	546/421	546/421	546/421	546/421	546/421
	4.19	Overall length	l ₁ mm	4086	3886	4086	3886	4096	3896	4163
	4.20	Length including fork backs	l ₂ mm	2886	2886	2886	2886	2896	2896	2963
	4.21	Overall width	b ₁ mm	1256	1256	1399	1399	1399	1399	1399
	4.22	Fork thickness	s mm	50	50	50	50	60	60	60
	4.22	Fork width	e mm	120	120	120	120	130	130	130
	4.22	Fork length	l mm	1200	1000	1200	1000	1200	1000	1200
	4.23	Fork carriage ISO 2328, Class/Form A, B		ISO III/A	ISO III/A	ISO III/A	ISO III/A	ISO III/A	ISO III/A	ISO III/A
	4.24	Fork carriage width	b ₃ mm	1200	1200	1200	1200	1310	1310	1310
	4.31	Floor clearance under mast, laden	m ₁ mm	150	150	150	150	150	150	150
	4.32	Floor clearance, centre of wheel-base	m ₂ mm	147	147	145	145	145	145	145
	4.34.1	Working aisle - 1000 x 1200 pallet crosswise	A _{st} mm	4208*	4208	4208*	4208	4218*	4218	4284*
4.34.2	Working aisle - 800 x 1200 pallet lengthways	A _{st} mm	4408	4408	4408	4408	4418	4418	4484	
4.35	Turning radius	W _a mm	2483	2483	2483	2483	2483	2483	2549	
4.36	Smallest pivot point distance	b ₁₃ mm	629	629	629	629	629	629	638	
Performance data	5.1	Travel speed laden	km/h	19	19	19	19	19	19	18
	5.1	Travel speed unladen	km/h	20	20	20	20	20	20	19
	5.2	Hoist speed laden	m/s	0.43	0.40	0.38	0.38	0.38	0.33	0.31
	5.2	Hoist speed unladen	m/s	0.55	0.55	0.46	0.46	0.46	0.46	0.44
	5.3	Lowering speed laden	m/s	0.55	0.55	0.55	0.55	0.55	0.55	0.55
	5.3	Lowering speed unladen	m/s	0.46	0.46	0.46	0.46	0.46	0.46	0.46
	5.5	Drawbar pull laden	N	3850	3770	3700	3620	3610	3600	3600
	5.5	Drawbar pull unladen	N	4390	4390	4470	4470	4400	4400	4400
	5.6	Max. drawbar pull laden	N	16000	15940	15900	15830	15750	15670	15670
	5.6	Max. drawbar pull unladen	N	16140	16140	16150	16150	16090	16090	16090
	5.7	Gradeability laden	%	11.9	11.3	10.6	9.5	9.2	8.8	7.4
	5.7	Gradeability unladen	%	17.0	17.0	16.8	16.8	15.8	15.8	13.7
	5.8	Max. gradeability laden	%	16.9	15.5	15.5	14.3	14.3	13.2	12.6
	5.8	Max. gradeability unladen	%	26.8	25.9	25.5	24.6	24.1	23.4	21.4
5.9	Acceleration time laden	s	5	5.1	5.1	5.2	5.2	5.3	5.4	
5.9	Acceleration time unladen	s	4.5	4.5	4.5	4.5	4.6	4.6	4.7	
5.10	Service brake		electr./mech.	electr./mech.	electr./mech.	electr./mech.	electr./mech.	electr./mech.	electr./mech.	
E-Motor	6.1	Drive motor, output S2 60 min	kW	15	15	15	15	15	15	15
	6.2	Lift motor, output for S3 15%	kW	25	25	25	25	25	25	25
	6.3	Battery to DIN 43531/35/36 A, B, C, No		DIN 43536 A	DIN 43536 A	DIN 43536 A	DIN 43536 A	DIN 43536 A	DIN 43536 A	DIN 43536 A
	6.4	Battery voltage	U V	80	80	80	80	80	80	80
	6.4.1	Battery capacity	K ₅ Ah	840 (-930)	840 (-930)	840 (-930)	840 (-930)	840 (-930)	840 (-930)	840 (-930)
	6.5	Battery weight	kg	2178	2178	2178	2178	2178	2178	2178
	6.6	Energy consumption 60 CDI cycles/hour	kWh/h	9.7	10.2	10.3	10.8	11.1	11.5	12.1
Miscellaneous	10.1	Working pressure for attachments	bar	250	250	250	250	250	250	250
	10.2	Oil flow for attachments	l/min	30	30	30	30	30	30	30
	10.7	Sound pressure level L _{PAZ} (driver's seat)***	dB (A)	<70	<70	<70	<70	<70	<70	<70
		Body vibrations in accordance with EN 13059	m/s ²							
	10.8	Towing coupler, Type/Model DIN		Pin	Pin	Pin	Pin	Pin	Pin	Pin

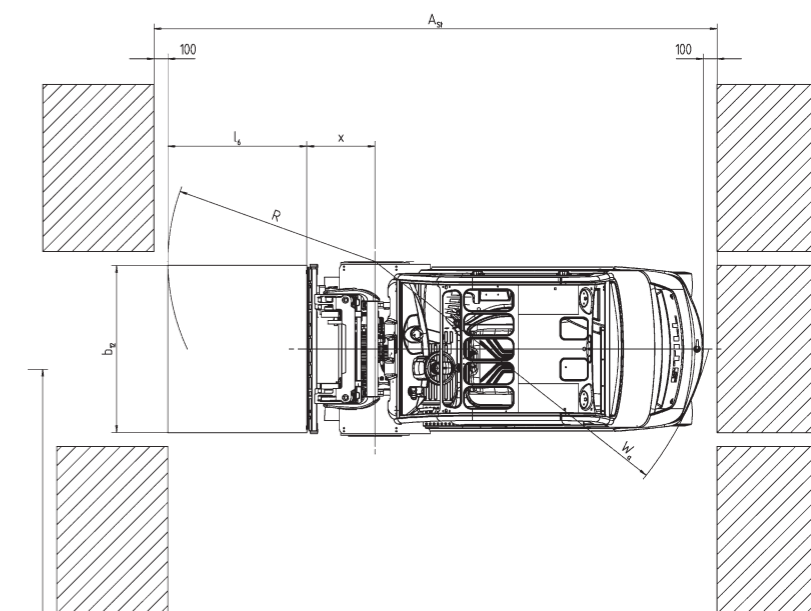
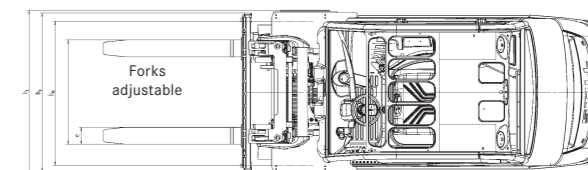
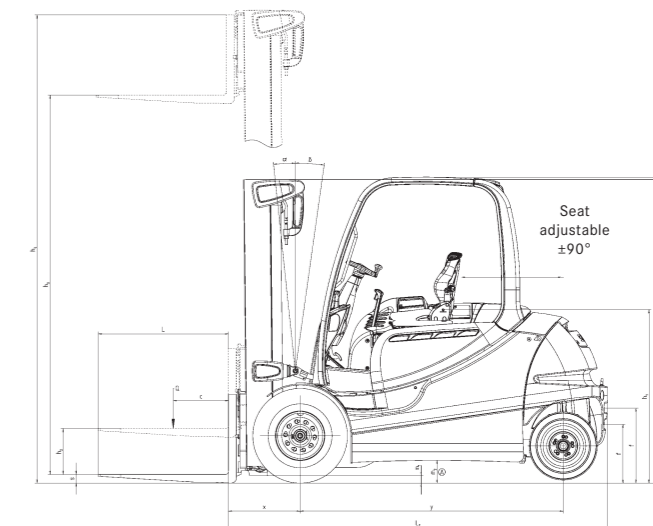

Dimensions relate to a vertical mast.

* calculated with 1000 mm long fork.

** The specified rated lift takes into consideration the tyre deflection and the tolerances of the tyre diameter.

*** With cabin, higher levels without cabin.

			Telescopic mast			Triplex mast		
RX 60-35/600	Rated lift	h ₃	mm	2980-4880		4030-4630	5080-7180	
	Overhall height	h ₁	mm	2300-3250		2150-2350	2500-3200	
	Free lift 4-roller carriage	h ₅	mm	160		1390-1590	1740-2440	
	Free lift 6-roller carriage	h ₅	mm	160		1238-1438	1588-2288	
	Greatest height 4-roller carriage	h ₄	mm	3762-5662		4835-5435	5885-7985	
	Greatest height 6-roller carriage	h ₄	mm	3987-5887		4987-5587	6037-8137	
	Forward tilt	α	°			3		
	Back tilt	β	°			9		
	Overall length	L ₂	mm			2886		
	Load distance	x	mm			525		
	Working isle width	A _{st}	mm			(1000 x 1200) 4208 // (1200 x 800) 4408		
	Tyres	v/h				250/70-15 // 200/75-9		355/50-15 // 200/75-9
	Track	v/h	mm			1030 // 920		1104 // 920
	Greatest width	B	mm			1256		1399
Fork locations, centre to centre		mm			191 368 572 673 876 978			
RX 60-40	Rated lift	h ₃	mm	2980-4080	4480-4880	4030-7180		
	Overhall height	h ₁	mm	2300-2850	3050-3250	2150-3200		
	Free lift 4-roller carriage	h ₅	mm	160	160	1390-2440		
	Free lift 6-roller carriage	h ₅	mm	160	160	1238-2288		
	Greatest height 4-roller carriage	h ₄	mm	3762-4862	5262-5662	4835-7985		
	Greatest height 6-roller carriage	h ₄	mm	3987-5087	5487-5887	4987-8137		
	Forward tilt	α	°			3		
	Back tilt	β	°			9		
	Overall length	L ₂	mm			2886		
	Load distance	x	mm			525		
	Working isle width	A _{st}	mm			(1000 x 1200) 4208 // (1200 x 800) 4408		
	Tyres	v/h		250/70-15 // 200/75-9		355/50-15 // 200/75-9		
	Track	v/h	mm	1030 // 920		1104 // 920		
	Greatest width	B	mm	1256		1399		
Fork locations, centre to centre		mm			191 368 572 673 876 978			
RX 60-45 RX 60-50 RX 60-40/600 RX 60-45/600	Rated lift	h ₃	mm	2980-4880				4030-7180
	Overhall height	h ₁	mm	2300-3250				2150-3200
	Free lift 4-roller carriage	h ₅	mm					1390-2440
	Free lift 6-roller carriage	h ₅	mm	160				1238-2288
	Greatest height 4-roller carriage	h ₄	mm					4835-7985
	Greatest height 6-roller carriage	h ₄	mm	3987-5887				4987-8137
	Forward tilt	α	°			3		
	Back tilt	β	°			9		
	Overall length	L ₂	mm			2886		
	Load distance RX 60-45, RX 60-40/600	x	mm			525		
	Load distance RX 60-50, RX 60-45/600	x	mm			535		
	Working isle width RX 60-45, RX 60-40/600	A _{st}	mm			(1000 x 1200) 4208 // (1200 x 800) 4408		
	Working isle width RX 60-50, RX 60-45/600	A _{st}	mm			(1000 x 1200) 4218 // (1200 x 800) 4418		
	Tyres	v/h				355/50-15 // 200/75-9		
Track	v/h	mm			1104 // 920			
Greatest width	B	mm			1399			
Fork locations, centre to centre		mm			191 368 572 673 978 1080			
RX 60-50/600	Rated lift	h ₃	mm	2780-4680				3730-6880
	Overhall height	h ₁	mm	2300-3250				2150-3200
	Free lift	h ₅	mm	160				1130-2180
	Greatest height 6-roller carriage	h ₄	mm	3887-5787				4795-7945
	Forward tilt	α	°			3		
	Back tilt	β	°			6		
	Overall length	L ₂	mm			2963		
	Load distance	x	mm			535		
	Working isle width	A _{st}	mm			(1000 x 1200) 4284 // (1200 x 800) 4484		
	Tyres	v/h				355/50-15 // 200/75-9		
	Track	v/h	mm			1104 // 920		
	Greatest width	B	mm			1399		
	Fork locations, centre to centre		mm			191 368 572 673 978 1080		

Gradients, maximum distance that can be driven in 60 minutes

Example: An RX 60-40 with a load of 4,000 kg and a gradient of 13% can drive a distance of 215 m 10 times per hour.

Unladen		RX 60-40	RX 60-45	RX 60-50	RX 60-35/600	RX 60-40/600	RX 60-45/600	RX 60-50/600
		23%	1850	1470	1430	1850	1470	1430
20%	2700	2290	2030	2700	2290	2030	1850	
15%	5390	5060	4350	5390	5060	4350	4140	
10%	7180	6930	6700	7180	6930	6700	6250	
5%	11660	11170	10720	11660	11170	10720	10260	
Laden	13%	2150	1590	1380	2450	1870	1450	0
	9%	4630	4200	3620	4880	4420	3920	3440
	7%	6070	5750	5380	6270	5900	5550	5150
	5%	7580	7100	6670	7840	7360	6880	6440

(dry rough concrete surface = Coefficient of friction 0.80)

Capacities RX 60-40 Tele/HiLo mast

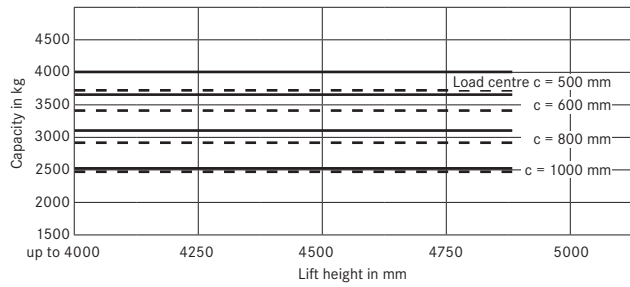

Capacities RX 60-40 with triplex mast

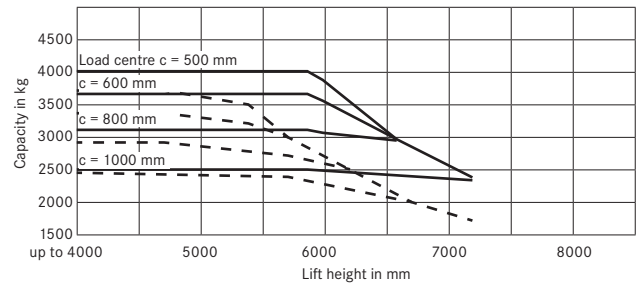

Capacities RX 60-45 Tele/HiLo mast (single tyres)

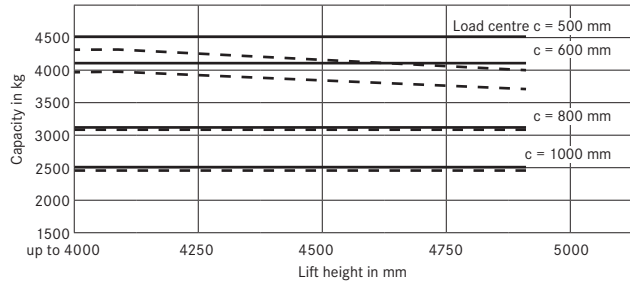

Capacities RX 60-45 Triplex mast/single tyres

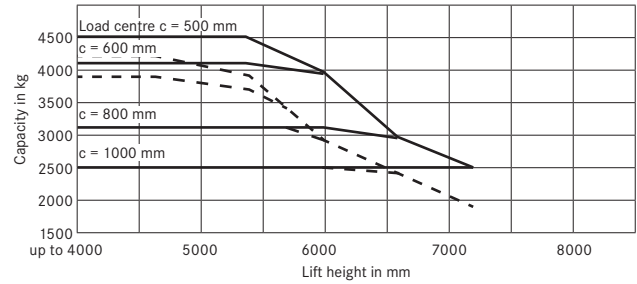

Capacities RX 60-50 Tele/HiLo mast

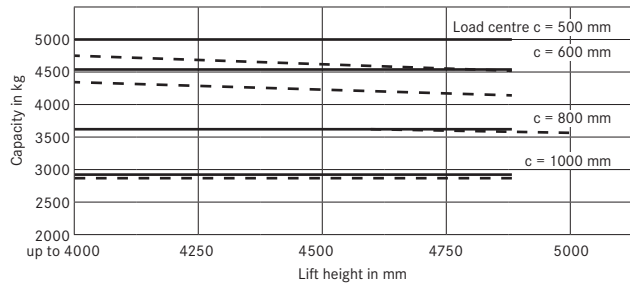

Capacities RX 60-50 Triplex mast/single tyres

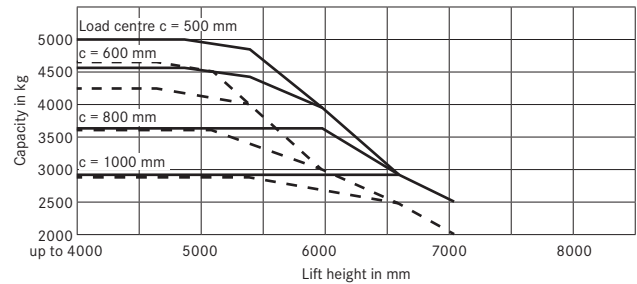

Capacities RX 60-45 Triplex mast/dual tyres

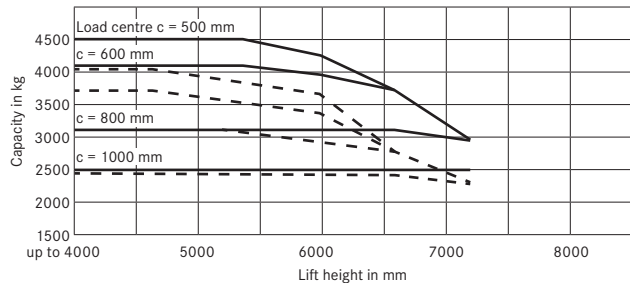

Capacities RX 60-50 Triplex mast/dual tyres

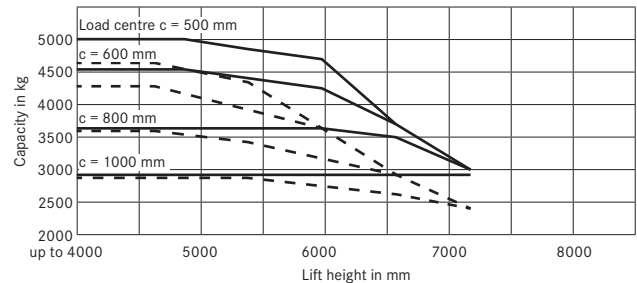

Capacities RX 60-35/600 Tele/HiLo mast

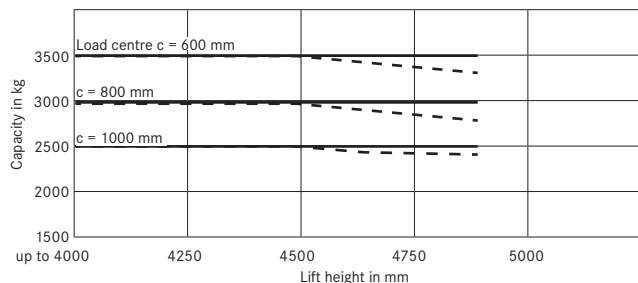

Capacities RX 60-35/600 with triplex mast

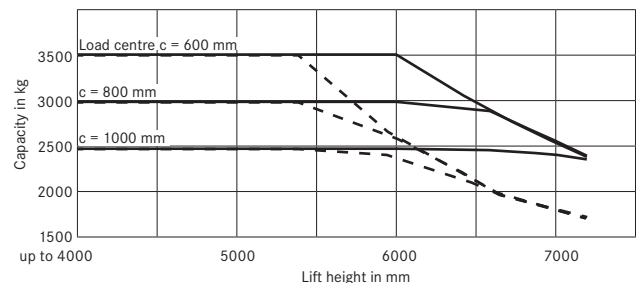

Capacities RX 60-40/600 Tele/HiLo mast

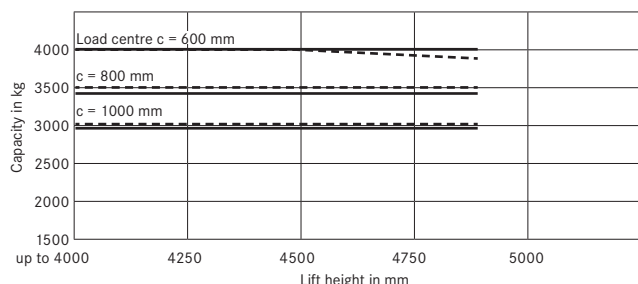

Capacities RX 60-40/600 with triplex mast

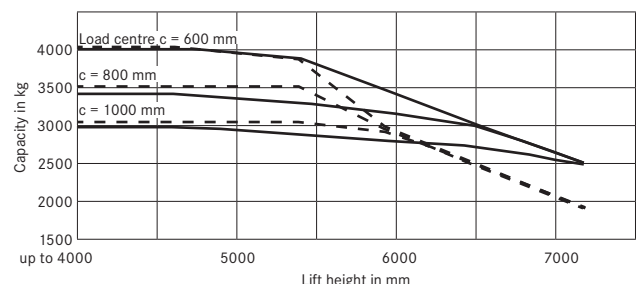

— without Sideshifter - - - with Sideshifter

Capacities RX 60-45/600 Tele/HiLo mast

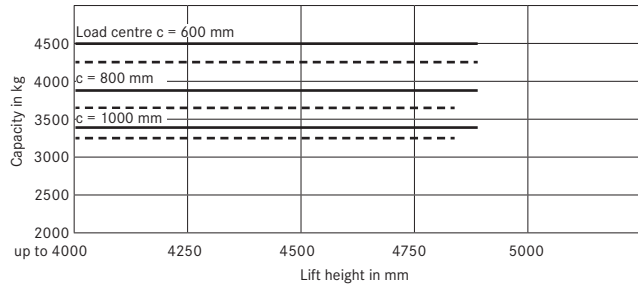

Capacities RX 60-45/600 with triplex mast

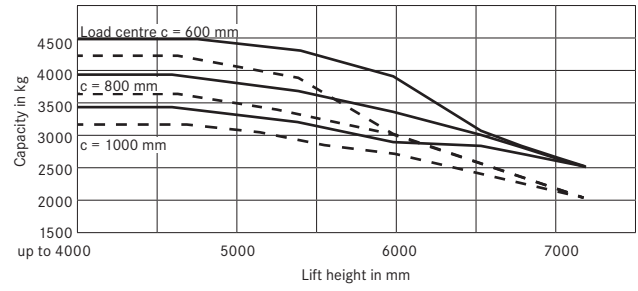

Capacities RX 60-50/600 Triple mast to BH2350

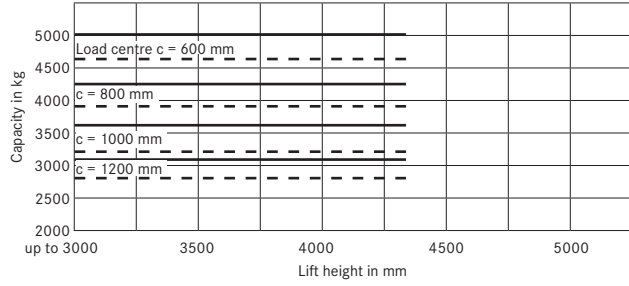

Capacities RX 60-50/600 Triple mast from BH2400

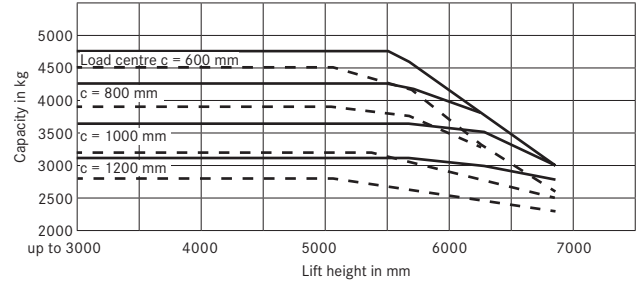

Capacities RX 60-50/600 Tele-mast to BH3250

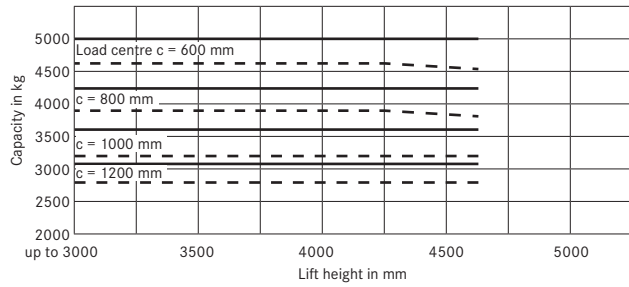

— without Sideshifter - - - with Sideshifter

Driver's compartment

The large footwell featuring an inclined floor plate and anti-slip lining provides quick and convenient entry and exit and a relaxed leg position when driving.

The adjustable steering column with its small steering wheel is ergonomically sound, requiring minimal steering movements from the driver. The automotive style pedal layout can be replaced by a dual pedal arrangement if required.

The drive direction switch on the valve lever (lift and lower) allows the driver to change direction without releasing his grip, thus reducing fatigue, even on long shifts.

The fully graphic display is heated to ensure that all essential information (including time, battery charge state, maintenance intervals, etc.) remains clearly visible under all conditions - even in extreme applications such as cold stores, or all-weather indoor/outdoor working.

The entire truck is under constant on-board diagnosis. With 5 selectable drive programs the driver can match the driving characteristics of the RX 60 to the application or his personal preferences. Each program can be precisely matched to the application profile in order to achieve optimum economy and load turnaround.

The driver's compartment of the RX 60 provides generous head room even for tall drivers, with good all-round vision thanks to the large viewing panels in the roof, very slim overhead guard legs and high seating position.

Blue-Q energy optimisation

- Activate Blue-Q energy saving mode on the truck at the push of a button.
- Energy saving due to intelligent optimisation of the drive characteristics without impairing the work process.
- Intelligently switches off electrical consumers.
- A saving in energy consumption of up to 20% depending on the application and the truck's equipment.

Safety

In conjunction with the mechanical parking and service brake, the RX 60 brakes automatically when the drive pedal is released, guaranteeing safe use at all times. The truck will also hold its position on a gradient without the need to depress the footbrake, further enhancing safety. The RX 60's side battery change can be carried out using a hand pallet truck, low lift pallet truck or forklift truck. This not only gives significant time savings compared to a conventional hoist, but makes the battery changing operation much safer. The risks of operator injury or truck damage are considerably reduced.

Service

The maintenance interval of the RX 60 is 1000 operating hours or 12 months. These intervals save time and maintenance costs - especially with single-shift operation, where 1000 hours roughly corresponds to annual operating hours, enabling the maintenance and UVV safety checks to be carried out at the same time. Fast diagnosis via a notebook computer and easily accessible maintenance components, together with readily available parts, guarantee short service times and maximum uptime.

Drive

The energy-efficient, noise-optimised three-phase drive unit of the RX 60 acts on the front wheels. High traction power and driving dynamics, even when climbing ramps or operating on uneven ground, ensure a high turnaround of goods. The 'BOOST' function

of the RX 60 is an innovative feature which, when required, calls up maximum torque from the drive motors. Maximum thrust is therefore always available - for example, at kerbs or when pushing pallets.

The maintenance-free, efficiency optimised three-phase drive guarantees a long battery operating life. Thanks to its IP 54 enclosure the entire drive system is protected against the ingress of dirt, dust and moisture, so that even the most inhospitable applications pose no problem.

In addition to all this, electrical regenerative braking means the motors feed back up to 15% of the energy into the battery when the drive pedal is released, increasing the work available from a battery charge by up to 1.5 hours. Interim battery charging, or even changing, is often not necessary. The STILL controller ensures sensitive driving response with optimal utilisation of energy. It also enables the truck to be held on ramps without using the maintenance-free multi-disc brakes, for greater safety and driving comfort. The power electronics are protected within the counterweight and the heat from the controller is dissipated into the counterweight over a large area. This arrangement provides very good cooling without additional fans or filters and makes operating the RX 60 reliable and quiet.

Electrical system

The RX 60 features digital control with two independent CAN bus systems which ensure that the drive train is not affected by minor electrical failures elsewhere on the truck, while the drive control unit has dual microprocessor monitoring to ensure safe operation. A pre-prepared wiring harness means that auxiliary electrical equipment can be fitted quickly and easily.

The RX 60 supports all functions of FleetManager 4.x: All information about the vehicle, such as the operating hours, deployment times and energy consumption, can be depicted transparently by way of the innovative online tool - anytime and anywhere. Control of the vehicle access entitlement by PIN, chip or an employee card also ensures maximum security when in operation.

Mast

A new generation of optimised visibility masts has been specially developed for this truck. The new concept is based on an outer mast C-section with hoist cylinders positioned behind the mast profiles. Depending on the application, the telescopic or triplex construction offer the following:

- Telescopic: an inexpensive mast design suitable for many applications, with full visibility through the mast.
- Triplex: for use where there are low doorways but high lift heights, to allow utilisation of warehouse space right up to the roof. Here too, there is a clear view through the mast due to the use of two free-lift cylinders.

Hydraulic system

The speed of the AC pump drive is demand controlled and is precisely regulated by the dynamic servo assistance through the valve lever or the steering wheel movement. This ensures longer use from a battery charge. Sensitive operation of hydraulics increases working safety thanks to positioning to the nearest millimetre. The hydraulics also improve energy consumption by:

- The high efficiency of the hydraulic pump. A noise reduced internal gear pump specially developed for this truck is used.
- The replacement of the pressure make-up valves with load holding valves. The priority valve for the steering is directly connected to the pump so that hydraulic interfaces and hoses are not required. This guarantees a safer, cleaner operation.



STILL Materials Handling Ltd
Aston Way
Leyland Preston
PR26 7UX
Tel.: +44 (0)845 603 6827
Fax: +44 (0)1772 454668

STILL Materials Handling Ltd
19 Hennock Road
Marsh Barton Trading Estate
Exeter
EX2 8RU
Tel.: +44 (0)1392 435151
Fax: +44 (0)1392 824328
info@still.co.uk
For further information please visit:
www.still.co.uk



STILL is certified in the following areas: Quality management, occupational safety, environmental protection and energy management.

