



FM-X Technical Data.

Rider Reach Trucks.

FM-X 10 (10 N)

FM-X 12 (12 N)

FM-X 14 (14 N)

FM-X 17 (17 N)

FM-X 20 (20 N)

FM-X 25



In accordance with VDI guidelines 2198, this specification sheet applies to the standard model only.
For special masts, attachments etc. specifications may vary.

					STILL	STILL	
Description	1.1	Manufacturer					
	1.2	Manufacturer's model designation			FM-X 10	FM-X 12	
	1.3	Drive (electric, diesel, petrol, LPG)			Electric	Electric	
	1.4	Operation (hand, pedestrian, stand-on, rider seated)			Seat	Seat	
	1.5	Load capacity	Q	kg	1000	1200	
	1.6	Load centre	c	mm	600	600	
	1.8	Load distance ¹⁾	x	mm	239	311	
	1.9	Wheel base	y	mm	1237	1309	
	Weights	2.1	Tare weight incl. battery		kg	2872	2889
2.3		Axle load closed fork, without load, drive side/load side		kg	1806/1066	1863/1026	
2.4		Axle load extended fork, with load, drive side/load side		kg	735/3137	664/3425	
2.5		Axle load closed fork, with load, drive side/load side		kg	1483/2389	1563/2526	
Wheels track		3.1	Tyres (solid rubber, Polyurethane, air)			Polyurethane	Polyurethane
	3.2	Tyre size drive side		mm	360x130	360x130	
	3.3	Tyre size load side		mm	310x102	310x102	
	3.5	Wheels, number (x = driven) load side/drive side			2/1 x	2/1 x	
	3.6	Track width, load side	b ₁₀	mm	1140	1140	
	3.7	Track width, drive side	b ₁₁	mm	-	-	
	Basic dimensions	4.1	Mast/fork carriage tilt, forward/backward ³⁾		°	1/3	1/3
4.2		Closed mast height	h ₁	mm	2450	2450	
4.3		Free lift	h ₂	mm	1890	1890	
4.4		Lift	h ₃	mm	5750	5750	
4.5		Extended mast height	h ₄	mm	6310	6310	
4.7		Height over OHG (cabin)	h ₆	mm	2200	2200	
4.8		Height of seat/stand	h ₇	mm	1050/550	1050/550	
4.10		Height of straddle legs/load wheel covers	h ₈	mm	330	330	
4.19		Overall length ²⁾	l ₁	mm	2379	2379	
4.20		Length incl. fork back ²⁾	l ₂	mm	1229	1229	
4.21		Overall width	b ₁ /b ₂	mm	1250/1220	1250/1220	
4.22		Dimension of fork teeth	s/e/l	mm	40/80/1150	40/100/1150	
4.23		Fork carriage DIN 15173, class/form A, B			2/A	2/A	
4.24		Width of fork carriage, top/bottom	b ₃	mm	850/730 GN/SS 850/650	850/730 GN/SS 850/650	
4.25		Outer fork width	b ₅	mm	600	620	
4.26		Width between straddle legs/load platform	b ₄	mm	920	920	
4.28		Forward shift ¹⁾	l ₄	mm	458	530	
4.31		Floor clearance beneath mast with load	m ₁	mm	90	90	
4.32		Floor clearance at centre of wheel base	m ₂	mm	81	81	
4.33		Width of working aisle for 1000 x 1200 pallets crosswise ²⁾	A _{st}	mm	2638	2654	
4.34	Width of working aisle for 800 x 1200 pallets lengthwise ²⁾	A _{st}	mm	2709	2715		
4.35	Turning radius	W _a	mm	1468	1540		
4.37	Length incl. load wheels	l ₇	mm	1641	1713		
Performance	5.1	Driving speed with/without load		km/h	12/12	14/14	
	5.2	Lift speed with/without load		m/s	0.47/0.70	0.45/0.70	
	5.3	Lowering speed with/without load		m/s	0.56/0.50	0.56/0.50	
	5.4	Shift speed with/without load ⁴⁾		m/s	0.15	0.15	
	5.7	Climbing capacity with/without load		%	10/15	10/15	
	5.8	Max. climbing capacity with/without load		%	15/20	15/20	
	5.9	Acceleration time with/without load (over 10 m)		s	4.8/4.5	4.9/4.6	
	5.10	Operation brake			gen./hydr.,mech.	gen./hydr.,mech.	
	Electric motors	6.1	Drive motor, S2 performance 60 min		kW	6.5	6.5
		6.2	Lift motor, S3 performance 15%		kW	13	13
6.3		Battery according to IEC 254-2; A,B,C, no			IEC 254-2, C	IEC 254-2, C	
6.4		Battery voltage, nominal capacity K ₅		V/Ah	420	420	
6.5		Weight of battery +/- 5% (depending on the manufacturer)		Kg	750	750	
6.6		Power consumption according to VDI cycle		kWh/h			
Other	8.1	Type of steering control			Three-phase	Three-phase	
	8.2	Operating pressure for attachments		bar	140	140	
	8.3	Oil quantity for attachments		l/min	18	18	
	8.4	Noise level at driver's ear		dB(A)	68	68	

All measurements including sideshift mast or sidshift forks (carriage)

¹⁾ Reduced in steps of 72 mm depending on the size of the battery.

²⁾ A_{st} extended in steps of 72 mm depending on the size of battery.

³⁾ May vary according to the mast, with side shift/fork tilt 2°/4°.

⁴⁾ Shift speed 0.13 m/s for closed mast heights h₁ = 3,600 mm and above.

STILL	STILL	STILL	STILL
FM-X 14	FM-X 17	FM-X 20	FM-X 25
Electric	Electric	Electric	Elektro
Seat	Seat	Seat	Seat
1400	1700	2000	2500
600	600	600	600
347	409	409	481
1381	1453	1525	1669
3174	3191	3408	3819
1998/1176	2050/1141	2162/1246	2413/1406
601/3973	484/4407	501/4907	585/5734
1702/2872	1791/3100	1870/3538	2184/4135
Polyurethane	Polyurethane	Polyurethane	Polyurethane
360x130	360x130	360x140	360x140
310x102	310x102	310x112	310x112
2/1 x	2/1 x	2/1 x	2/1 x
1140	1140	1150	1150
-	-	-	-
1/3	1/3	1/3	1/3
2450	2450	2450	2450
1890	1880	1880	1828
5750	5750	5580	5580
6310	6320	6150	6202
2200	2200	2235	2235
1050/550	1050/550	1085/585	1085/585
330	330	332	332
2415	2425	2497	2569
1265	1275	1347	1419
1250/1220	1250/1220	1270/1220	1270/1220
40/100/1150	50/100/1150	50/100/1150	50/120/1150
2/A	2/A	2/A	2/A
850/730 GN/SS 850/650	850/730 GN/SS 850/650	850/730 GN/SS 850/650	850/730 GN/SS 850/650
620	620	620	640
920	920	920	920
565	633	633	710
90	90	90	100
81	81	81	81
2699	2727	2800	2894
2755	2771	2844	2923
1612	1684	1757	1900
1785	1857	1935	2073
14/14	14/14	14/14	14/14
0.43/0.68	0.40/0.68	0.34/0.58	0.30/0.50
0.56/0.52	0.55/0.52	0.53/0.50	0.52/0.50
0.15	0.15	0.15	0.15
10/15	10/15	10/15	10/15
15/20	15/20	15/20	15/20
5.1/4.7	5.3/4.8	5.5/5	5.5/5
gen./hydr.,mech.	gen./hydr.,mech.	gen./hydr.,mech.	gen./hydr.,mech.
6.5	6.5	6.5	6.5
13	13	13	13
IEC 254-2, C	IEC 254-2, C	IEC 254-2, C	IEC 254-2, C
420	48/420	48/560	48/700
750	750	940	1120
Three-phase	Three-phase	Three-phase	Three-phase
140	140	140	140
18	18	18	18
68	68	68	68

Load capacities FM-X 10 (10 N)

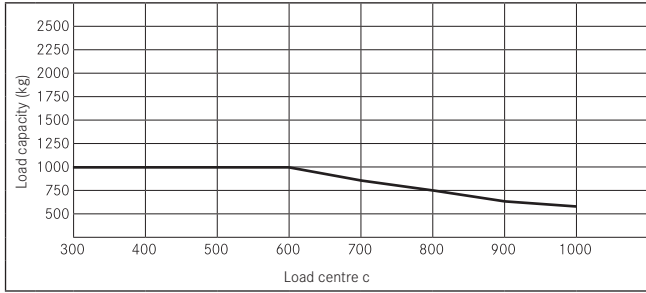

Load capacities FM-X 12 (12 N)

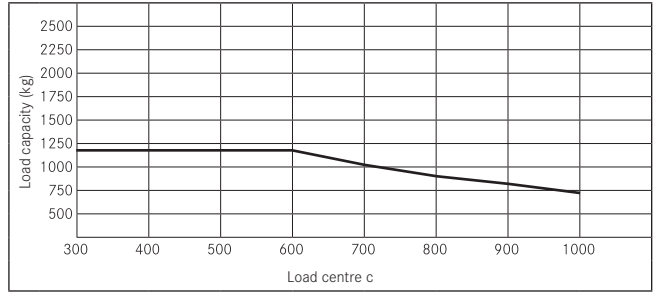

Load capacities FM-X 14 (14 N)

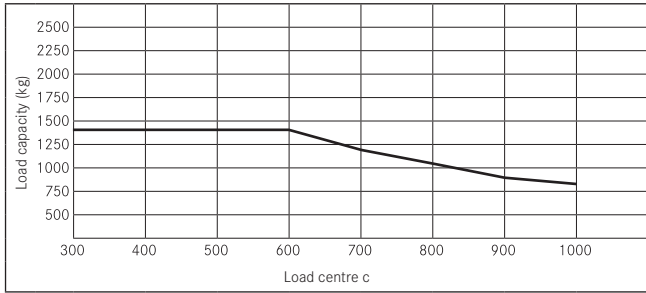

Load capacities FM-X 17 (17 N)

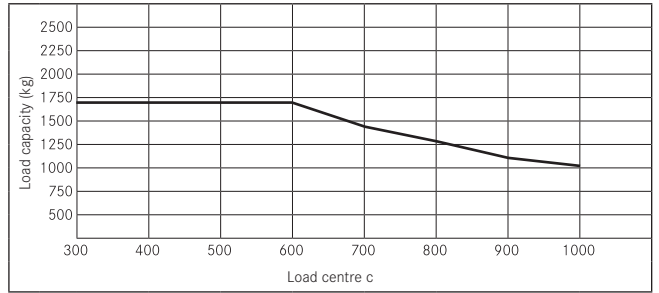

Load capacities FM-X 20 (20 N)

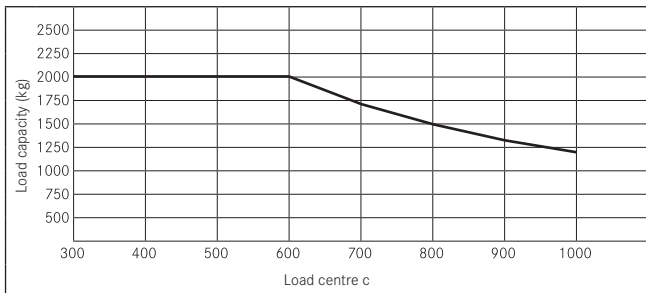

Load capacities FM-X 25

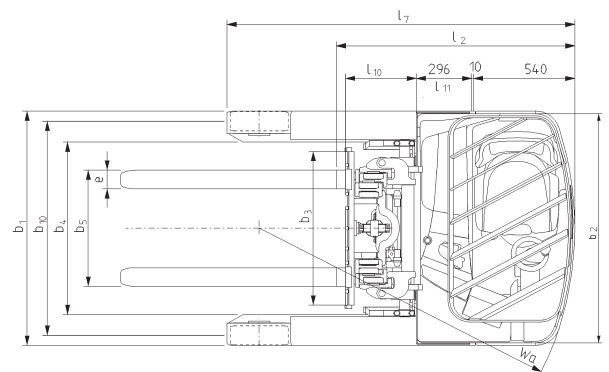
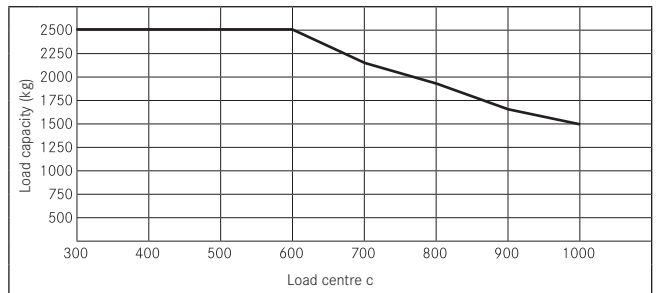

In accordance with VDI guidelines 2198, this specification sheet applies to the standard model only.
For special masts, attachments, tyres etc. specifications may vary.

				STILL	STILL	STILL	
Description	1.1	Manufacturer		FM-X 10N	FM-X 12N	FM-X 14N	
	1.2	Manufacturer's model designation		Electric	Electric	Electric	
	1.3	Drive (electric, diesel, petrol, LPG)		Seat	Seat	Seat	
	1.4	Operation (hand, pedestrian, stand-on, rider seated)		1000	1200	1400	
	1.5	Load capacity/load	Q	kg	600	600	600
	1.6	Load centre	c	mm	149	221	266
	1.8	Load distance ¹⁾	x	mm	1237	1309	1381
	1.9	Wheel base	y	mm	2825	2842	3127
	Weights	2.1	Tare weight incl. battery		kg	1650/1175	1711/1131
2.3		Axle load closed fork, without load, drive side/load side		kg	610/3215	537/3505	475/4052
2.4		Axle load extended fork, with load, drive side/load side		kg	1252/2573	1323/2719	1448/3079
2.5		Axle load closed fork, with load, drive side/load side		kg	Polyurethane	Polyurethane	Polyurethane
3.1		Tyres (solid rubber, polyurethane, air)			360x130	360x130	360x130
Wheels track	3.2	Tyre size drive side		mm	310x102	310x102	310x102
	3.3	Tyre size load side		mm	2/1 x	2/1 x	2/1 x
	3.5	Wheels, number (x = driven) load side/drive side			1010	1010	1010
	3.6	Track width, load side	b ₁₀	mm	-	-	-
	3.7	Track width, drive side	b ₁₁	mm	2/4	2/4	2/4
	4.1	Mast tilt/fork tilt forward/backward		°	2450	2450	2450
	4.2	Closed mast height	h ₁	mm	1890	1890	1890
Basic dimensions	4.3	Free lift	h ₂	mm	5750	5750	5750
	4.4	Lift	h ₃	mm	6310	6310	6310
	4.5	Extended mast height	h ₄	mm	2200	2200	2200
	4.7	Height over OHG (cabin)	h ₆	mm	1050/550	1050/550	1050/550
	4.8	Height of seat/stand	h ₇	mm	330	330	330
	4.10	Height of straddle legs/covers	h ₈	mm	2469	2469	2496
	4.19	Overall length ²⁾	l ₁	mm	1319	1319	1346
	4.20	Length incl. fork back ²⁾	l ₂	mm	1120/1090	1120/1090	1120/1090
	4.21	Overall width	b ₁ /b ₂	mm	40/80/1150	40/100/1150	40/100/1150
	4.22	Dimension of fork teeth	s/e/l	mm	2A	2A	2A
	4.23	Fork carriage DIN 15173, class/form A, B			850/650	850/650	850/650
	4.24	Width of fork carriage, top/bottom	b ₃	mm	600	620	620
	4.25	Outer fork width	b ₅	mm	790	790	790
	4.26	Width between straddle legs/load platform	b ₄	mm	387	457	494
	4.28	Forward shift ¹⁾	l ₄	mm	90	90	90
	4.31	Floor clearance beneath mast with load	m ₁	mm	81	81	81
	4.32	Floor clearance at centre of wheel base	m ₂	mm	2710	2724	2761
	4.33	Width of working aisle for 1000 x 1200 pallets crosswise ²⁾	A _{st}	mm	2793	2798	2829
	4.34	Width of working aisle for 800 x 1200 pallets lengthwise ²⁾	A _{st}	mm	1468	1540	1612
4.35	Turning radius	W _a	mm	1641	1713	1785	
4.37	Length incl. load wheels	l ₇	mm				
Performance	5.1	Driving speed with/without load		km/h	12/12	14/14	14/14
	5.2	Lift speed with/without load		m/s	0.47/0.70	0.45/0.70	0.43/0.68
	5.3	Lowering speed with/without load		m/s	0.56/0.50	0.56/0.50	0.56/0.52
	5.4	Shift speed with/without load ⁴⁾		m/s	0.15	0.15	0.15
	5.7	Climbing capacity with/without load		%	10/15	10/15	10/15
	5.8	max. climbing capacity with/without load		%	15/20	15/20	15/20
	5.9	Acceleration time with/without load (over 10 m)		s	4.8/4.5	4.9/4.6	5.1/4.7
5.10	Operation brake			gen./hydr.,mech.	gen./hydr.,mech.	gen./hydr.,mech.	
Electric motors	6.1	Drive motor, S2 performance 60 min		kW	6.5	6.5	6.5
	6.2	Lift motor, S3 performance 15%		kW	13	13	13
	6.3	Battery according to IEC 254-2; A,B,C, no			IEC 254-2, B	IEC 254-2, B	IEC 254-2, B
	6.4	Battery voltage, nominal capacity K _s		V/Ah	420	420	420
	6.5	Weight of battery +/- 5% (depending on the manufacturer)		Kg	750	750	750
	6.6	Power consumption according to VDI cycle		kWh/h			
Other	8.1	Type of steering control			Three-phase	Three-phase	Three-phase
	8.2	Operating pressure for attachments		bar	140	140	140
	8.3	Oil quantity for attachments		l/min	18	18	18
	8.4	Noise level at driver's ear		dB(A)	68	68	68

All measurements including sideshift mast or sidshift forks (carriage)

¹⁾ Reduced in steps of 90 mm depending on the size of the battery.

²⁾ A_{st} extended in steps of 90 mm depending on the size of battery.

³⁾ Shift speed 0.13 m/s for closed mast heights h₁ = 3,600 mm and above.

STILL	STILL
FM-X 17N	FM-X 20N
Electric	Electric
Seat	Seat
1700	2000
600	600
328	310
1453	1525
3144	3352
1898/1246	1978/1374
356/4488	350/5002
1530/3314	1541/3811
Polyurethane	Polyurethane
360x130	360x140
310x102	310x112
2/1 x	2/1 x
1010	1010
-	-
2/4	2/4
2450	2450
1880	1880
5750	5580
6320	6150
2200	2200
1050/550	1050/550
330	330
2506	2596
1356	1446
1120/1090	1120/1090
50/100/1150	50/100/1150
2A	2A
850/650	850/650
620	620
790	790
565	547
90	90
81	81
2788	2871
2847	2932
1687	1756
1857	1929
14/14	14/14
0.40/0.68	0.34/0.58
0.55/0.52	0.53/0.50
0.15	0.15
10/15	10/15
15/20	15/20
5.3/4.8	5.5/5
gen./hydr.,mech.	gen./hydr.,mech.
6.5	6.5
13	13
IEC 254-2, B	IEC 254-2, B
420	560
750	940
Three-phase	Three-phase
140	140
18	18
68	68

Driver's compartment.

- Spacious driver's compartment with adjustable controls. The driver is always inside the contour of the vehicle for maximum safety.
- Damped driver's compartment (optional) reduces shocks from uneven floors and therefore the likelihood of back injuries.
- Proportional adjustment of seat and footplate (optional), electrically controlled. Ergonomic control layout ensures an optimum all-round view regardless of the driver's physique.
- Comfortable, tilting seat with multiple adjustment to suit individual drivers, plus tilting mast, enable a good view of the load while reducing the potential for neck injuries.
- Open access steps allow easy entry and exit.
- Large individual storage compartments, DIN A4 document compartment, bottle holder.
- Overhead guard designed for 360° visibility and maximum safety.

Controls.

- Ergonomic joystick allows operation of all hydraulic movements without changing grip; integrated buttons control auxiliary hydraulics; stick weighted to enable the driver to "feel" the driving direction; all movements can be operated simultaneously; maintenance-free sensor technology.
- Optional 4-lever control of hydraulic functions.
- Full electric 360° steering (optional 180°) for smooth, precise positioning. The number of revolutions for a 360° steering angle can be set to suit the driver or the conditions in the warehouse.
- Direct-drive safety steering system.
- Self-centring steering for stable, fatigue-free straight-line travel at all speeds.

Drives.

- Powerful maintenance-free drives for driving, lifting and steering, with energy recovery during braking.
- Fully encapsulated AC drives, which provide powerful acceleration and regenerative braking, are protected against dust and water ingress.

Hydraulics.

- Proportional valve technology for silent, fast and sensitive movements.
- Noise-optimised pump drive with improved efficiency.
- Automatic fork and side shift centering at the press of a button (optional). Immediate centering ensures the safe alignment of a pallet between the load wheels and horizontal positioning of the forks, especially with height pre-selection systems.
- High throughput of goods is provided by fast, safe working speeds for lifting/lowering, mast shift forwards, sideways and tilt.
- Shift measuring system allows soft and variable speed transitions.
- Single valve block and power chain with hydraulic quick-locks mean low service and maintenance costs.

Mast.

- Triplex free view mast with free lift; special profiles with high torsion resistance. Routing chains and pipes within the contour of the cylinders allows maximum visibility through the mast.
- Standard mast side shift with free-view fork carriage. Absence of hydraulic pipes provides greater visibility and also makes for easier serviceability. The mast tilt moves the centre of gravity towards the truck.
- Optional integrated side shift with fork tilt for less movement of loads at high lift heights.
- The narrow construction of the mast allows optimum view around the load.
- End of reach damping minimises mast transition noise.

Brake system.

- Maintenance-free regenerative braking with energy recovery and high efficiency.
- Maximum safety by 3-circuit brake system. Regenerative braking when releasing the accelerator pedal. When operating the brake pedal additional regenerative deceleration is activated. If the pedal is pressed further the hydraulic load wheel brake is actuated.
- Electromagnetic disc brake for emergency stop and parking.

Electrical equipment.

- LCD display with automatic brightness adjustment. Clear, user-friendly display of all operating states. Indicator wizard for height pre-selection assists the driver and helps safely increase throughput when stacking and retrieving.
- Truck control with five drive programs. Driving speed, acceleration and braking characteristics can be set independently for each driving direction, and also to suit the driver or the conditions in the warehouse.
- Lift height indication, lift height pre-selection and camera systems all contribute to an efficient warehousing process and help increase the throughput of goods.
- FleetManager or PIN code system and optional keyless access provide an overview of the operation of the fleet and prevent unauthorised use of the vehicle.
- Electrical and mechanical interfaces for easy retro-fitting of warehouse administration and truck control systems.

Battery.

- Exchange by hoist or, optionally, laterally with roller conveyor.
- High performance reserve for single and multi-shift operations due to battery capacities up to 930 Ah.
- Intelligent battery management limits the maximum current when lifting and ensures a long service life of the battery.

Service.

- Easy removal of the covers to allow best access for service.
- Simple diagnostics and parameterisation.
- Extended diagnostics via central interface.

Safety.

- CSC (Curve Speed Control) automatically reduces speed on bends to ensure maximum safety when being operated by inexperienced drivers or handling fragile loads.
- Optispeed system (optional) governs the lift and lower speeds to the maximum safe rate for the load weight and operating height: uncomfortable, stepped speed changes as the mast rises are done away with, the truck always operates at optimum performance, and realisable gains in productivity are achieved. Extended Optispeed packages are available which further adapt truck functions to warehouse conditions.
- The trucks are built in accordance with the EC machinery guideline 98/37/EG and are CE labelled.
- STILL is certified to ISO-9001.

	FM-X											
	10	12	14	17	20	25	10N	12N	14N	17N	20N	
Driver's space	Adjustable position of the steering wheel and horizontal adjustment of the seat	●	●	●	●	●	●	●	●	●	●	●
	Comfort seat with hydraulic damping and weight adjustment	●	●	●	●	●	●	●	●	●	●	●
	Comfort tilt seat	○	○	○	○	○	○	-	-	-	-	-
	Damped driver's compartment for best comfort on uneven floors and thresholds	○	○	○	○	○	○	-	-	-	-	-
	Heated seat	○	○	○	○	○	○	○	○	○	○	○
	Imitation leather seat with vinyl upholstery	○	○	○	○	○	○	○	○	○	○	○
	Proportional adjustment of the seat and foot plate	○	○	○	○	○	○	-	-	-	-	-
	Free view mast with view optimised over head guard	●	●	●	●	●	●	●	●	●	●	●
	Joystick (hydraulic control without changing grip)	●	●	●	●	●	●	●	●	●	●	●
	Fingertip (hydraulic control with 4 levers)	○	○	○	○	○	○	○	○	○	○	○
	5 driving profiles, selectable by the driver	●	●	●	●	●	●	●	●	●	●	●
	Integrated storage compartments, bottle holder	●	●	●	●	●	●	●	●	●	●	●
Display: clear display of the current status	●	●	●	●	●	●	●	●	●	●	●	
Steering	Full electric 360° degree steering	●	●	●	●	●	●	●	●	●	●	
	Full electric 180° steering	○	○	○	○	○	○	○	○	○	○	
	Full electric steering with reverse function	○	○	○	○	○	○	○	○	○	○	
	Redundant safety system for steering	●	●	●	●	●	●	●	●	●	●	
Mast	Triplex free view mast with free lift	●	●	●	●	●	●	●	●	●	●	
	Hydraulic mast side shift with mast tilt	●	●	●	●	●	●	-	-	-	-	
	Hydraulic side shift with fork tilt	-	○	○	○	○	○	●	●	●	●	
	Mast transition damping	●	●	●	●	●	●	●	●	●	●	
	Free view fork carriage	●	●	●	●	●	●	●	●	●	●	
Hydraulics	Noise optimised hydraulic pump	●	●	●	●	●	●	●	●	●	●	
	Additional hydraulics, single or double	-	-	○	○	○	○	-	-	○	○	
	Proportional valve technology for sensitive movements	●	●	●	●	●	●	●	●	●	●	
	Individual parameterisation of the hydraulic functions	●	●	●	●	●	●	●	●	●	●	
Drives	Simultaneous movement of several hydraulic functions	●	●	●	●	●	●	●	●	●	●	
	Stepless acceleration up to the maximum speed	●	●	●	●	●	●	●	●	●	●	
	Maintenance-free drives for driving, lift and steering	●	●	●	●	●	●	●	●	●	●	
	Fully capsulated components protected against dirt and dust	●	●	●	●	●	●	●	●	●	●	
Brakes	Integrated current and temperature sensors monitoring the functions	●	●	●	●	●	●	●	●	●	●	
	Regenerative brake system	●	●	●	●	●	●	●	●	●	●	
	Energy recuperation when braking	●	●	●	●	●	●	●	●	●	●	
	Hydraulic load wheel brake as additional brake	●	●	●	●	●	●	●	●	●	●	
Additional safety and performance	Electromagnetic disc brake as parking brake and for emergency stops	●	●	●	●	●	●	●	●	●	●	
	Keyless pin code access with button	○	○	○	○	○	○	○	○	○	○	
	Flash light	○	○	○	○	○	○	○	○	○	○	
	360° light	○	○	○	○	○	○	○	○	○	○	
	Spot lights	○	○	○	○	○	○	○	○	○	○	
	Macrolon or mesh wire OHG cover	○	○	○	○	○	○	○	○	○	○	
	Steering angle controlled speed reduction	○	○	○	○	○	○	○	○	○	○	
	Lift switch-off for intermediate lift and/or lift end position	○	○	○	○	○	○	○	○	○	○	
	Lift height indication	-	○	○	○	○	○	-	○	○	○	
	Lift height pre-selection	-	○	○	○	○	○	-	-	○	○	
	Fleet Manager: access control	○	○	○	○	○	○	○	○	○	○	
	Optispeed: Lift height and load controlled speed reduction	○	○	○	○	○	○	○	○	○	○	
	Energy recuperation lowering	-	-	○	○	○	○	-	-	○	○	
	Acoustic travel warning (Digisound)	○	○	○	○	○	○	○	○	○	○	
Battery system	Battery exchange by hoist	●	●	●	●	●	●	●	●	●	●	
	Battery conveyor for lateral exchange of battery	○	○	○	○	○	○	○	○	○	○	
	Tray for 420 Ah battery	●	●	●	●	-	-	●	●	●	-	
	Tray for 560 Ah battery	○	○	○	○	●	-	○	○	○	●	
	Tray for 700 Ah battery	-	-	○	○	○	●	-	-	○	○	
	Tray for 900 Ah battery	-	-	-	-	○	○	-	-	-	○	
Additional equipment	Battery transport and exchange rack	○	○	○	○	○	○	○	○	○	○	
	Different fork lengths	○	○	○	○	○	○	○	○	○	○	
	Preparation data terminal	○	○	○	○	○	○	○	○	○	○	
	Automatic Fork tilt and side shift centring on pressing a button	-	○	○	○	○	○	-	○	○	○	
	Cold storage version	○	○	○	○	○	○	○	○	○	○	
	Cold storage package	-	○	○	○	○	○	-	○	○	○	
	Heated comfort cold storage cabin	-	○	○	○	○	○	-	-	-	-	
	Heated comfort cold storage cabin, drive in version	-	-	-	-	-	-	-	○	○	○	
	Track width 1650/1670 mm	-	-	○	○	○	○	-	-	-	-	
	Load rest	○	○	○	○	○	○	○	○	○	○	
	Panoramic rear view mirror	○	○	○	○	○	○	○	○	○	○	
	Overhead guards for drive-in racks	○	○	○	○	○	○	○	○	○	○	
	Lateral guide rollers for drive-in racks	○	○	○	○	○	○	○	○	○	○	
	Load wheel covers	○	○	○	○	○	○	○	○	○	○	
Shift and lowering lock	○	○	○	○	○	○	○	○	○	○		
Fork tooth camera system	-	○	○	○	○	○	-	-	○	○		
Two-pedal version	○	○	○	○	○	○	○	○	○	○		

● Standard

○ Option





Your contact

STILL GmbH

Berzeliusstraße 10

D-22113 Hamburg

Telephone: +49 (0)40/73 39-2000

Telefax: +49 (0)40/73 39-2001

info@still.de

For further information please visit:

www.still.de

STILL Materials Handling Ltd.

Aston Way, Leyland

Lancashire PR26 7UX

Telephone: +44 (0)1772 644300

Telefax: +44 (0)1772 644303

info@still.co.uk

For further information please visit:

www.still.co.uk